

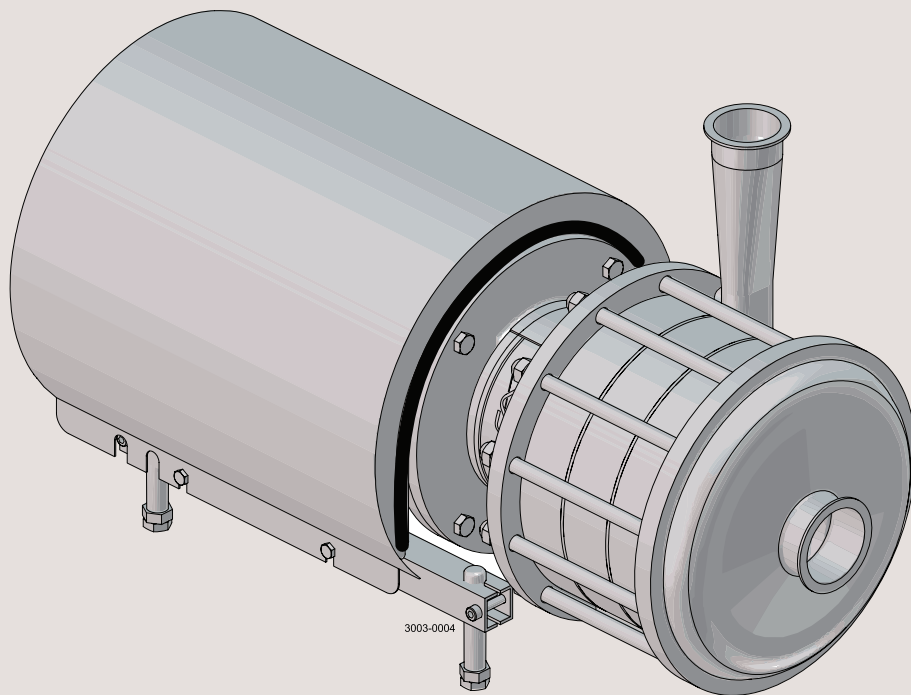

## Spare Parts

LKH-110, -120 Multi-Stage Centrifugal Pump



ESE00719-EN23 2025-10

Original manual



## Table of contents

---

*The information herein is correct at the time of issue but may be subject to change without prior notice*

1. LKH Multi-Stage - Wet end .....	4
2. LKH Multi-Stage - Motor dependent parts .....	12
3. LKH Multi-Stage - Shaft seal and service kits .....	18

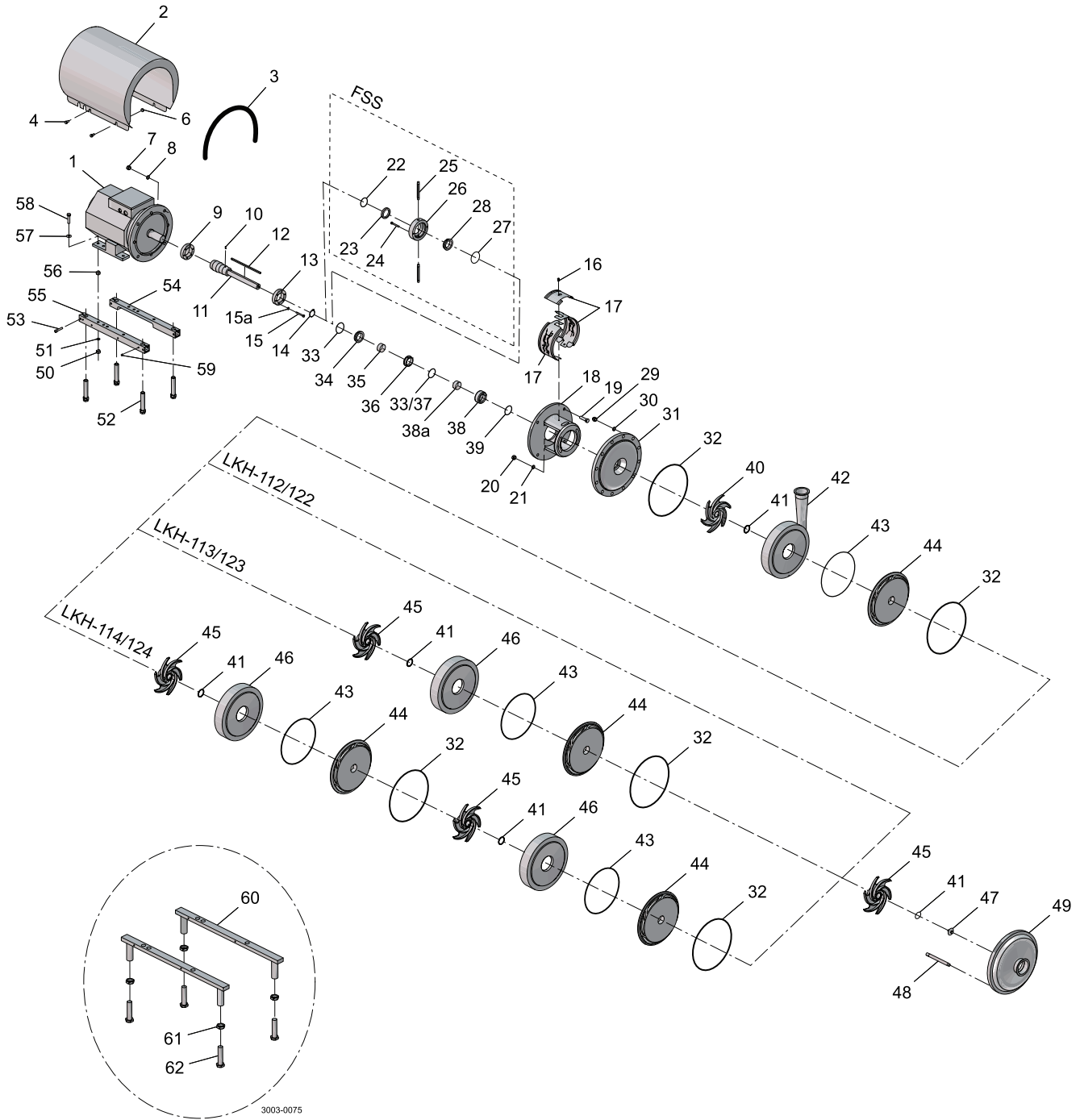

Pos	Qty Denomination	LKH-112	LKH-113	LKH-114
		IEC90- IEC160	IEC100- IEC160	IEC132- IEC180
<b>Pump Casing std. blasted</b>				
42	Pump casing, male part IDF .....	9612388901	9612388901	9612388901
	Pump casing, male part SMS .....	9612388902	9612388902	9612388902
	Pump casing, DIN .....	9612388903	9612388903	9612388903
	Pump casing, ferrule ISO .....	9612388904	9612388904	9612388904
	Pump casing, male part BS .....	9612388905	9612388905	9612388905
	Pump casing, flange DN40 .....	9612389401	9612389401	9612389401

<b>Pump Cover std. blasted</b>				
49	Pump Cover, male part IDF .....	9612389301	9612389301	9612389301
	Pump Cover, male part SMS .....	9612389302	9612389302	9612389302
	Pump cover, DIN .....	9612389303	9612389303	9612389303
	Pump Cover, ferrule ISO .....	9612389304	9612389304	9612389304
	Pump Cover, male part BS .....	9612389305	9612389305	9612389305
	Pump cover, flange DN50 .....	9612389501	9612389501	9612389501

Pos	Qty Denomination	LKH-112P	LKH-113P	LKH-114P
		IEC90- IEC160	IEC100- IEC160	IEC132- IEC180
<b>Pump Casing std. blasted</b>				
42	Pump casing, male part IDF .....	9612388901	9612388901	9612388901
	Pump casing, male part SMS .....	9612388902	9612388902	9612388902
	Pump casing, DIN .....	9612388903	9612388903	9612388903
	Pump casing, ferrule ISO .....	9612388904	9612388904	9612388904
	Pump casing, male part BS .....	9612388905	9612388905	9612388905
	Pump casing, flange DN40 .....	9612389401	9612389401	9612389401

<b>Pump Cover std. blasted</b>				
49	Pump Cover, male part IDF .....	9612389301	9612389301	9612389301
	Pump Cover, male part SMS .....	9612389302	9612389302	9612389302
	Pump cover, DIN .....	9612389303	9612389303	9612389303
	Pump Cover, ferrule ISO .....	9612389304	9612389304	9612389304
	Pump Cover, male part BS .....	9612389305	9612389305	9612389305
	Pump cover, flange DN50 .....	9612389501	9612389501	9612389501

Pos	Qty Denomination	LKH-122	LKH-123	LKH-124
		IEC180- IEC200	IEC180- IEC250	IEC200- IEC250
<b>Pump Casing std. blasted</b>				
42	Pump casing, compl. Flange .....	9612592301	9612592301	9612592301
	Pump casing, compl. Clamp .....	9612592302	9612592302	9612592302
<b>Pump Cover std. blasted</b>				
49	Pump cover, compl. Flange .....	9612592401	9612592401	9612592401
	Pump cover, compl. Clamp .....	9612592402	9612592402	9612592402

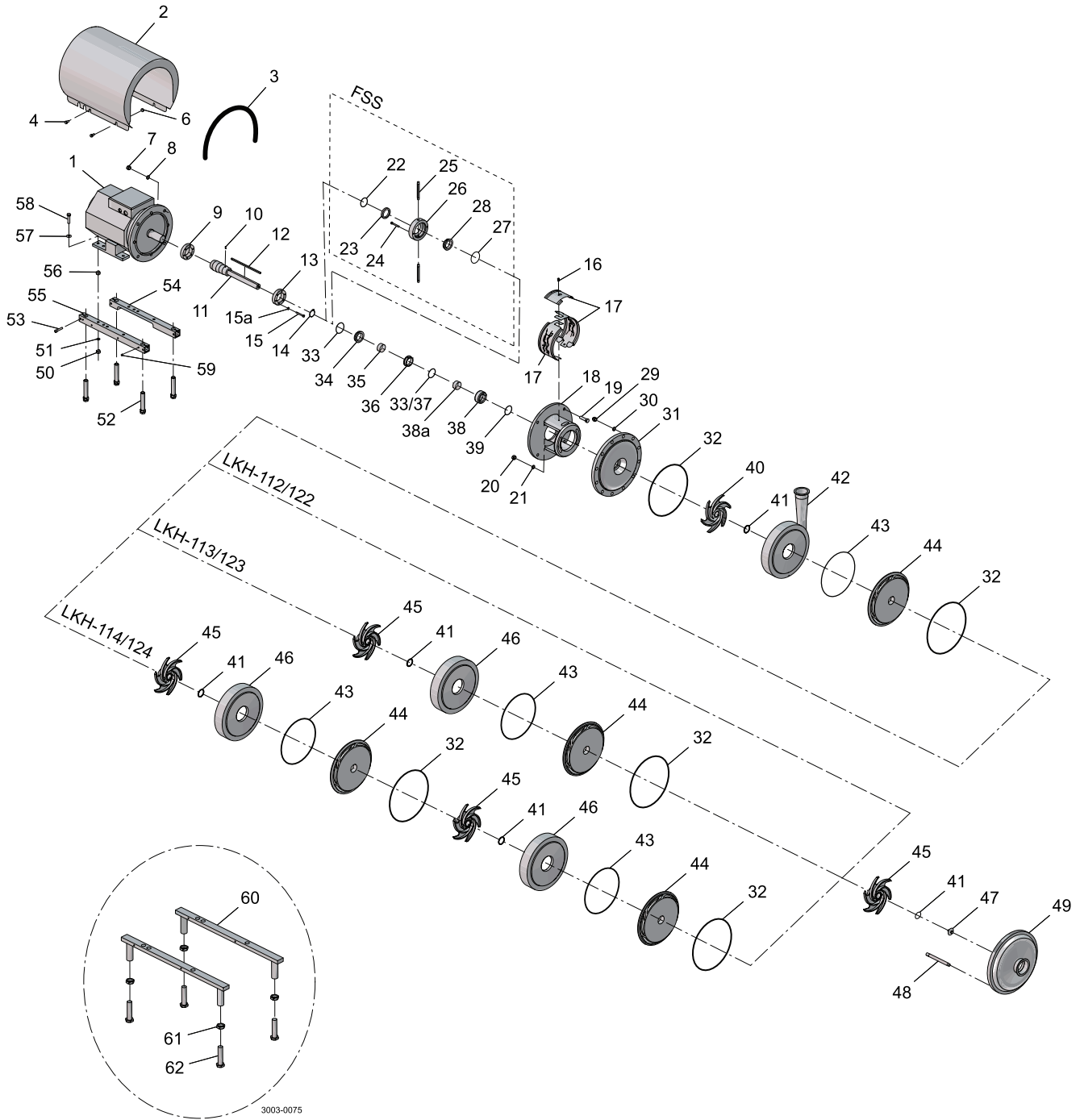

Pos	Qty	Denomination	LKH-112 IEC90- IEC160	LKH-113 IEC100- IEC160	LKH-114 IEC132- IEC180
29	6	Cap nut .....	9611992593	9611992593	9611992593
30	6	Washer .....	9611991887	9611991887	9611990676
48	6	Bolt .....	9612363501	9612363502	9612363503
43	1	O-ring, EPDM, (standard) .....	9611992747		
		O-ring, NBR .....	9611992748		
		O-ring, FPM .....	9611992749		
	2	O-ring, EPDM, (standard) .....		9611992747	
		O-ring, NBR .....		9611992748	
		O-ring, FPM .....		9611992749	
	3	O-ring, EPDM, (standard) .....			9611992747
		O-ring, NBR .....			9611992748
		O-ring, FPM .....			9611992749
41	2	O-ring, EPDM, (standard) .....	9611992750		
		O-ring, NBR .....	9611992751		
		O-ring, FPM .....	9611992752		
	3	O-ring, EPDM, (standard) .....		9611992750	
		O-ring, NBR .....		9611992751	
		O-ring, FPM .....		9611992752	
	4	O-ring, EPDM, (standard) .....			9611992750
		O-ring, NBR .....			9611992751
		O-ring, FPM .....			9611992752
32	2	O-ring, EPDM, (standard) .....	9611992744		
		O-ring, NBR .....	9611992745		
		O-ring, FPM .....	9611992746		
	3	O-ring, EPDM, (standard) .....		9611992744	
		O-ring, NBR .....		9611992745	
		O-ring, FPM .....		9611992746	
	4	O-ring, EPDM, (standard) .....			9611992744
		O-ring, NBR .....			9611992745
		O-ring, FPM .....			9611992746
44	1	Guide vanes blasted .....	9612361301		
	2	Guide vanes blasted .....		9612361301	
	3	Guide vanes blasted .....			9612361301
46	1	Intermediate casing blasted .....		9612361001	
	2	Intermediate casing blasted .....			9612361001
40	1	Impeller back std. blasted .....	9612360401	9612360401	9612360401
45	1	Impeller std. blasted .....	9612360501		
	2	Impeller std. blasted .....		9612360501	
	3	Impeller std. blasted .....			9612360501
47	1	Impeller screw std. Blasted .....	9612362701	9612362701	9612362701
31	1	Back plate std. blasted, (0-10 bar) .....	9612389208	9612389208	9612389208
20	2	Nut .....	9611990353	9611990353	9611990353
21	2	Washer .....	9611992559	9611992559	9611992559
12	1	Key .....	9611992756	9611992757	9611992758
63	1	Set of 8 springs for rotating sealhousing, (incl. In pos 38) .....	9611995848	9611995848	9611995848

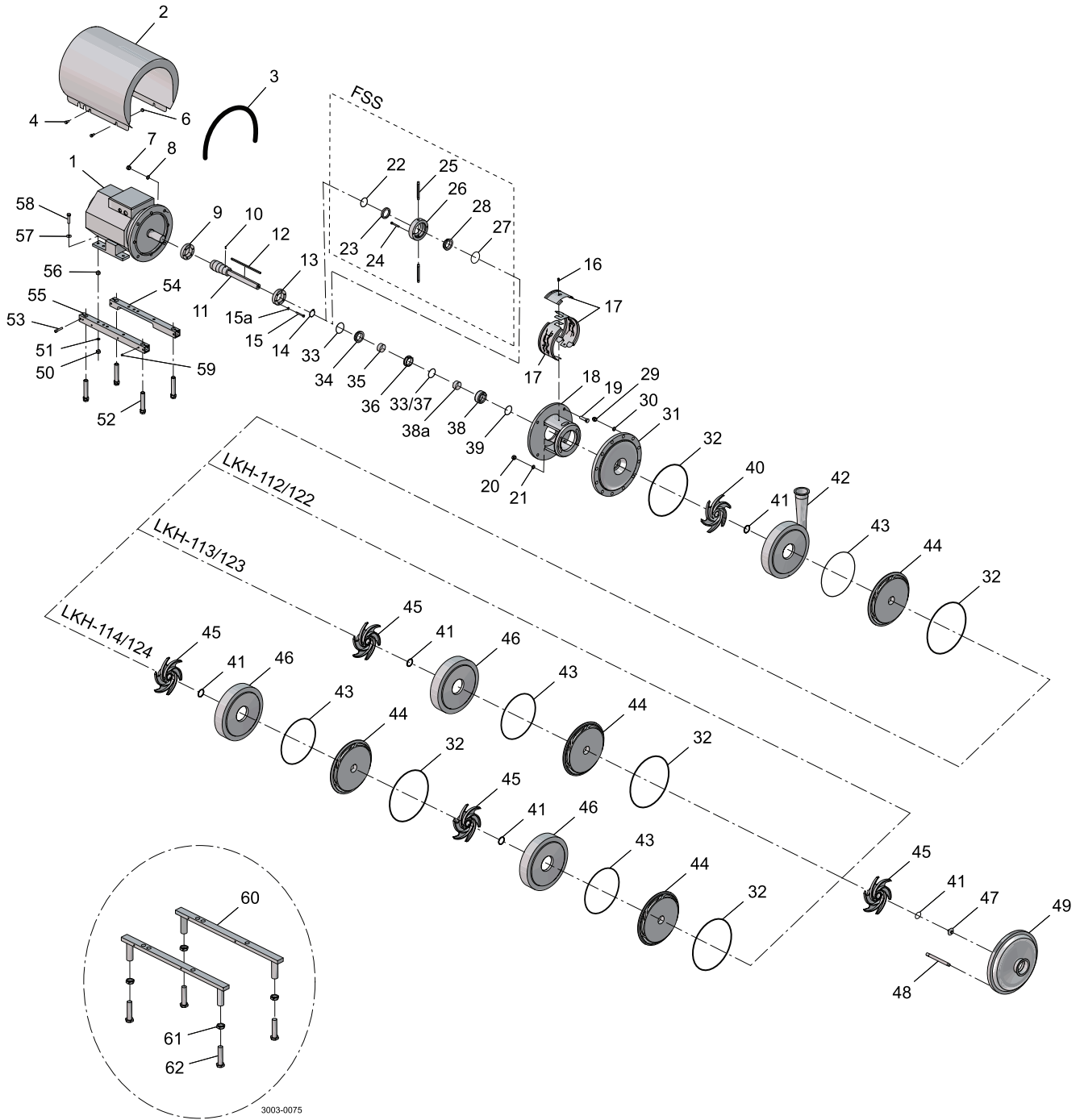

Pos	Qty	Denomination	LKH-112P	LKH-113P	LKH-114P
			IEC90- IEC160	IEC100- IEC160	IEC132- IEC180
29	6	Cap nut .....	9611992593	9611992593	9611992593
30	6	Washer .....	9611991887	9611991887	9611990676
48	6	Bolt .....	9612363501	9612363502	9612363503
43	1	O-ring, EPDM, (standard) .....	9611992747		
		O-ring, NBR .....	9611992748		
		O-ring, FPM .....	9611992749		
	2	O-ring, EPDM, (standard) .....		9611992747	
		O-ring, NBR .....		9611992748	
		O-ring, FPM .....		9611992749	
	3	O-ring, EPDM, (standard) .....			9611992747
		O-ring, NBR .....			9611992748
		O-ring, FPM .....			9611992749
41	2	O-ring, EPDM, (standard) .....	9611992750		
		O-ring, NBR .....	9611992751		
		O-ring, FPM .....	9611992752		
	3	O-ring, EPDM, (standard) .....		9611992750	
		O-ring, NBR .....		9611992751	
		O-ring, FPM .....		9611992752	
	4	O-ring, EPDM, (standard) .....			9611992750
		O-ring, NBR .....			9611992751
		O-ring, FPM .....			9611992752
32	2	O-ring, EPDM, (standard) .....	9611992744		
		O-ring, NBR .....	9611992745		
		O-ring, FPM .....	9611992746		
	3	O-ring, EPDM, (standard) .....		9611992744	
		O-ring, NBR .....		9611992745	
		O-ring, FPM .....		9611992746	
	4	O-ring, EPDM, (standard) .....			9611992744
		O-ring, NBR .....			9611992745
		O-ring, FPM .....			9611992746
44	1	Guide vanes blasted .....	9612361301		
	2	Guide vanes blasted .....		9612361301	
	3	Guide vanes blasted .....			9612361301
46	1	Intermediate casing blasted .....		9612361001	
	2	Intermediate casing blasted .....			9612361001
40	1	Impeller back std. blasted .....	9612360401	9612360401	9612360401
45	1	Impeller std. blasted .....	9612360501		
	2	Impeller std. blasted .....		9612360501	
	3	Impeller std. blasted .....			9612360501
47	1	Impeller screw std. blasted .....	9612362701	9612362701	9612362701
31	1	Back plate std. blasted, (≤ 10 bar) .....	9612389214	9612389214	9612389214
20	2	Nut .....	9611990353	9611990353	9611990353
21	2	Washer .....	9611992559	9611992559	9611992559
12	1	Key .....	9611992756	9611992757	9611992758
63	1	Set of 8 springs for rotating sealhousing, (incl. in pos 38) .....	9611995848	9611995848	9611995848

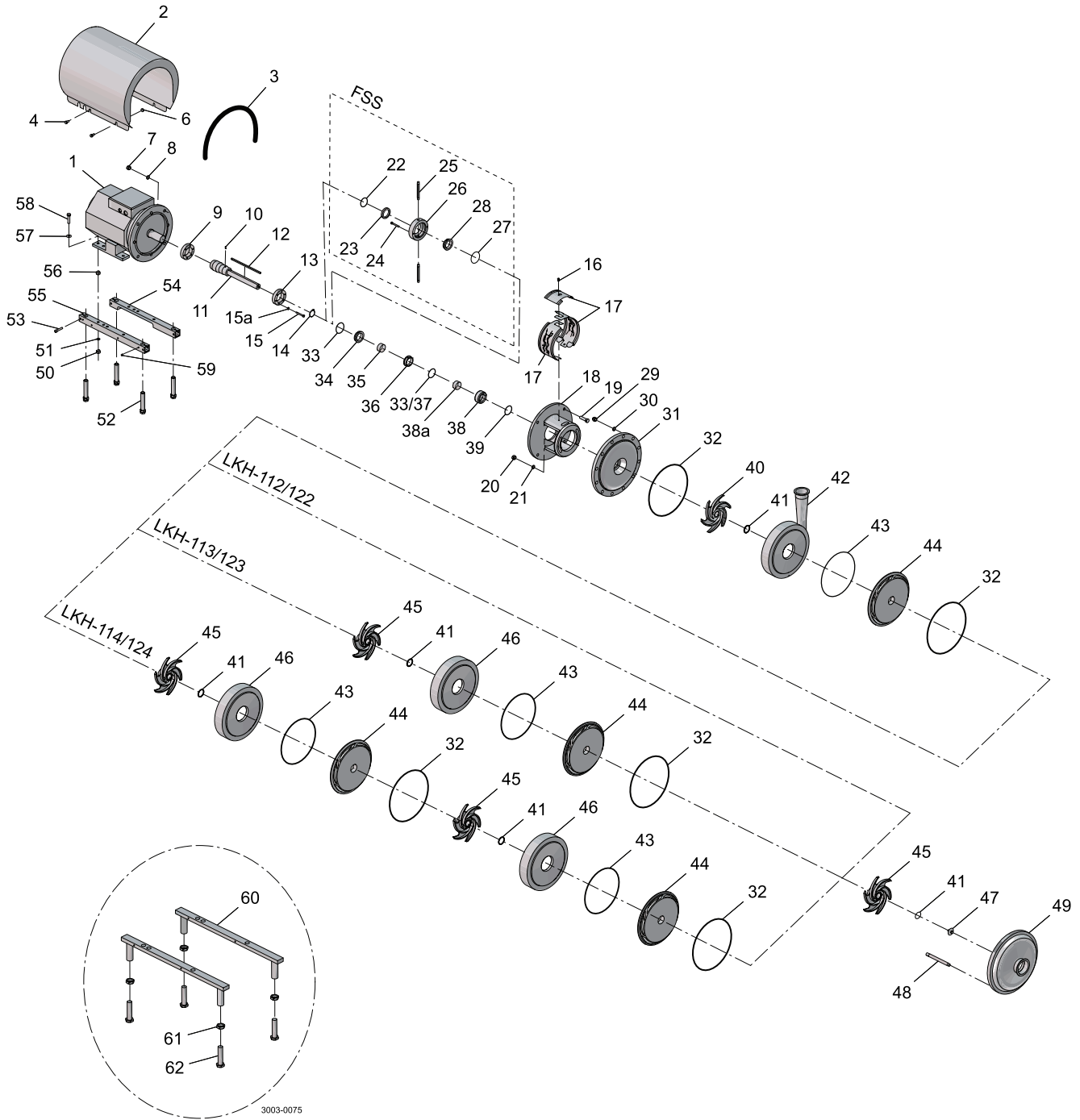

Pos	Qty	Denomination	LKH-122 IEC180- IEC200	LKH-123 IEC180- IEC250	LKH-124 IEC200- IEC250
29	11	Cap nut .....	9611993685	9611993685	9611993685
30	11	Washer .....	9611993684	9611993684	9611993684
48	11	Bolt .....	9612363506	9612363507	9612363508
43	1	O-ring, EPDM, (standard) .....	9611993582		
		O-ring, NBR .....	9611993583		
		O-ring, FPM .....			
	2	O-ring, EPDM, (standard) .....		9611993582	
		O-ring, NBR .....		9611993583	
		O-ring, FPM .....			
	3	O-ring, EPDM, (standard) .....			9611993582
		O-ring, NBR .....			9611993583
		O-ring, FPM .....			
41	2	O-ring, EPDM, (standard) .....	9611993578		
		O-ring, NBR .....	9611993579		
		O-ring, FPM .....			
	3	O-ring, EPDM, (standard) .....		9611993578	
		O-ring, NBR .....		9611993579	
		O-ring, FPM .....			
	4	O-ring, EPDM, (standard) .....			9611993578
		O-ring, NBR .....			9611993579
		O-ring, FPM .....			
32	2	O-ring, EPDM, (standard) .....	9611993574		
		O-ring, NBR .....	9611993575		
		O-ring, FPM .....			
	3	O-ring, EPDM, (standard) .....		9611993574	
		O-ring, NBR .....		9611993575	
		O-ring, FPM .....			
	4	O-ring, EPDM, (standard) .....			9611993574
		O-ring, NBR .....			9611993575
		O-ring, FPM .....			
44	1	Guide vanes blasted .....	9612590302		
	2	Guide vanes blasted .....		9612590302	
	3	Guide vanes blasted .....			9612590302
46	1	Intermediate casing blasted .....		9612590902	
	2	Intermediate casing blasted .....			9612590902
40	1	Impeller back std. blasted .....	9612590604	9612590604	9612590604
45	1	Impeller std. blasted .....	9612590603		
	2	Impeller std. blasted .....		9612590603	
	3	Impeller std. blasted .....			9612590603
47	1	Impeller screw std. blasted .....	9612591304	9612591304	9612591304
31	1	Back plate std. blasted, (10 ≤ bar) .....	9612389224	9612389224	9612389224
20	2	Nut .....	9611990353	9611990353	9611990353
21	2	Washer .....	9611992559	9611992559	9611992559
12	1	Key .....	9611993476	9611992758	9611993474
63	1	Set of 8 springs, for rotating sealhousing (incl. In pos 38) .....	9611995849	9611995849	9611995849

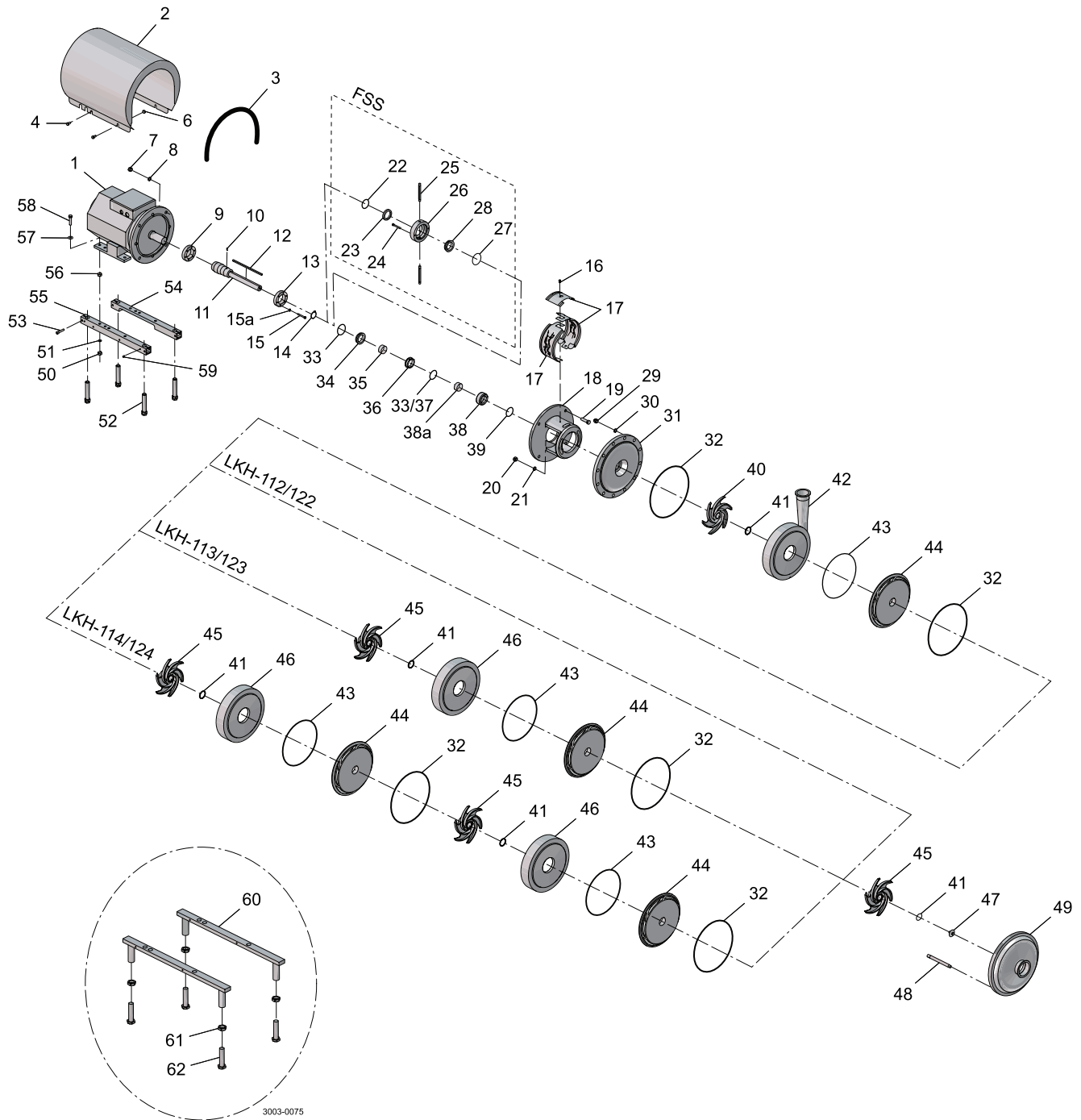

LKH Multi-Stage - Motor dependent parts

Pos	Qty	Denomination	IEC90	IEC100	IEC112
2	1	Shroud .....	9612139001	9614192203	9612139003
3	1	Edge list, (Included in pos. 2) .....			
4	4	Screw .....	9611993240	9611993240	9611993240
9	1	Compression ring, with thread .....	9612133601	9612133602	9612133602
13	1	Compression ring, without thread .....	9612133701	9612133702	9612133702
15	6	Screw .....	9611993196	9611993196	9611993196
15a	6	Washer .....	9611993199	9611993199	9611993199
11	1	Shaft, LKH112/LKH112P single shaft seal .....	9612389601	9612361901	9612361901
	1	Shaft, LKH113/LKH113P single shaft seal .....		9612361902	9612361902
	1	Shaft incl. pin, (pos.8) LKH112/LKH112P flushed shaft seal .....	9612389602	9612361903	9612361903
	1	Shaft incl. pin, (pos.8) LKH113/LKH113P flushed shaft seal .....		9612361904	9612361904
10	1	Connex pin, for flushed shaft seal .....	9611990622	9611990622	9611990622
14	1	Retaining ring .....	9611992307		
17	1	Safety guard set .....	9614077401	9614077402	9614077402
	1	Safety Guard left new .....	9615270101	9615270201	9615270201
	1	Safety Guard right new .....	9615270111	9615270211	9615270211
	1	Top Plate new .....	9615271301	9615271401	9615271401
16	1	Screw, for safety guard .....	9611993239	9611993239	9611993239
18	1	Adaptor .....	9612342301	9612342401	9612342401
19	4	Screw for adaptor .....	9611992161	9611991834	9611991834
8	4	Washer for adaptor .....	9611991887	9611990676	9611990676
7	4	Nut for adaptor .....	9611990353	9611990587	9611990587
55	1	Support bar, right .....	9612132201	9612132205	9612132205
54	1	Support bar, left .....	9612132301	9612132305	9612132305
52	4	Leg .....	9612396701	9612396701	9612396701
50	4	Nut .....	9611990360	9611990353	9611990353
51	4	Spring washer .....	9611991888	9611991887	9611991887
58	4	Screw .....	9611993241	9611991911	9611991911
57	4	Washer .....		9611990786	9611990786
56	4	Nut .....		9611990587	
53	4	Screw .....	9611991907	9611991907	9611991907
6	4	Distance sleeve .....		9611992737	

Pos	Qty	Denomination	IEC132	IEC160	IEC180
2	1	Shroud .....	9612139008	9612139005	9612139006
3	1	Edge list, (Included in pos. 2) .....			
4	4	Screw .....	9611993240	9611993241	9611993240
9	1	Compression ring with thread .....	9612133605	9612133603	9612133604
13	1	Compression ring without thread .....	9612133705	9612133703	9612133704
15	6	Screw .....	9611993197	9611993197	9611993198
15a	6	Washer .....	9611993199	9611993199	9611993199
11	1	Shaft, LKH112/LKH112P single shaft seal .....	9612362001	9612362101	
	1	Shaft, LKH113/LKH113P single shaft seal .....	9612362002	9612362102	
	1	Shaft, LKH114/LKH114P single shaft seal .....	9612362003	9612362103	9612514801
	1	Shaft incl. pin , (pos.8) LKH112/LKH112P flushed shaft seal .....	9612362004	9612362104	
	1	Shaft incl. pin, (pos.8) LKH113/LKH113P flushed shaft seal .....	9612362005	9612362105	
	1	Shaft incl. pin , (pos.8) LKH114/LKH114P flushed shaft seal .....	9612362006	9612362106	9612514802
	1	Shaft incl. pin, (pos.8) LKH122 .....			9612592001
	1	Shaft incl. pin, (pos.8) LKH123 .....			9612592002
	1	Shaft incl. pin, (pos.8) LKH124 .....			9612592003
10	1	Connex pin, for flushed shaft seal .....	9611990622	9611990622	9611990622
17	1	Safety guard set .....	9614077403	9614077404	9614077404
	1	Safety Guard left new .....	9615270101	9615270201	9615270201
	1	Safety Guard right new .....	9615270311	9615270411	9615270411
	1	Top Plate new .....	9615271501	9615271601	9615271601
16	1	Screw for safety guard .....	9611993239	9611993239	9611993239
18	1	Adaptor .....	9612342501	9612342601	9612342601
19	4	Screw for adaptor .....	9611992162	9611992163	9611992164
8	4	Washer for adaptor .....	9611990676	9611991886	9611991886
7	4	Nut for adaptor .....	9611990587	9611992160	9611992160
55	1	Support bar, right .....	9612132206	9612132203	9612132204
54	1	Support bar, left .....	9612132306	9612132303	9612132304
52	4	Leg .....	9612396701	9612396701	9612396701
50	4	Nut .....	9611990353	9611990587	9611990587
51	4	Spring washer .....	9611991887	9611990676	9611990676
58	4	Screw .....	9611991911	9611991834	9611991834
57	4	Washer .....	9611990786	9611990706	9611990706
53	4	Screw .....	9611991907	9611991907	9611991907
6	4	Distance sleeve .....	9611992737	3143803902	

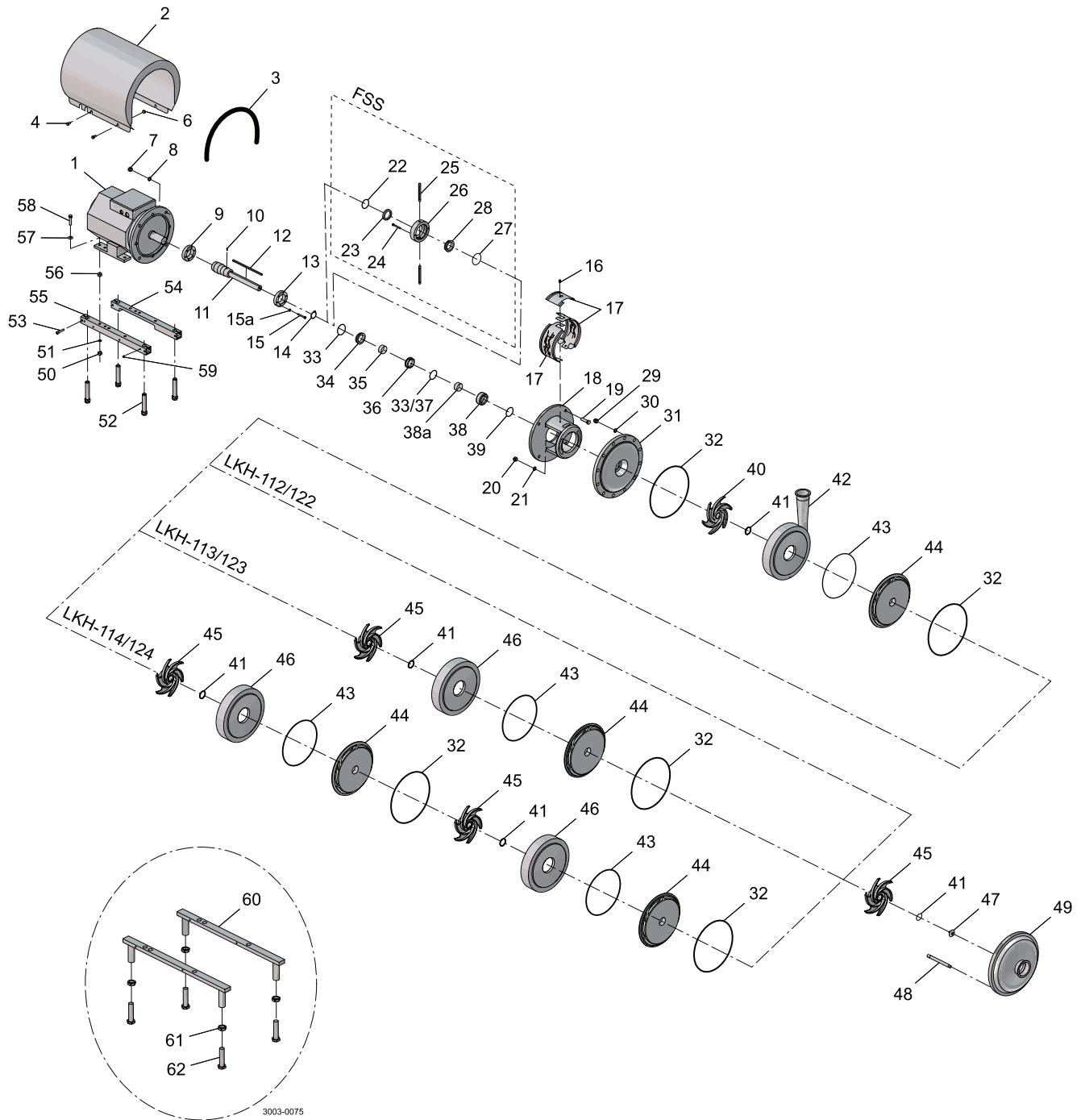

LKH Multi-Stage - Motor dependent parts

Pos	Qty	Denomination	IEC200	IEC250
2	1	Shroud .....	9612593801	9612593804
4	4	Screw .....	9611993243	9611993242
9	1	Compression ring with thread .....	9612133607	9612133608
13	1	Compression ring without thread .....	9612133707	9612133708
15	6	Screw .....	9611993198	9611993266
15a	6	Washer .....	9611993199	9611993199
11	1	Shaft incl. pin, (pos.8) LKH122 .....	9612592101	
	1	Shaft incl. pin, (pos.8) LKH123 .....	9612592102	9612592202
	1	Shaft incl. pin, (pos.8) LKH124 .....	9612592103	9612592203
10	1	Connex pin, for flushed shaft seal .....	9611990622	9611990622
17	1	Safety guard set .....	9614077404	9614077418
	1	Safety Guard left new .....	9615270401	9615270501
	1	Safety Guard right new .....	9615270411	9615270511
	1	Top Plate new .....	9615271601	9615271701
16	1	Screw for safety guard .....	9611993239	9611993239
18	1	Adaptor .....	9612342701	9612591501
19	4	Screw for adaptor .....	9611992164	
8	4	Washer for adaptor .....	9611991886	
7	4	Nut for adaptor .....	9611992160	
19	8	Screw for adaptor .....		9611992200
8	8	Washer for adaptor .....		9611991886
7	8	Nut for adaptor .....		9611992160
55	1	Support bar, right .....	9612342201	
54	1	Support bar, left .....	9612342201	
52	4	Leg .....	9612396701	
50	4	Nut .....	9611990587	9611990935
51	4	Spring washer .....	9611990676	9611993267
58	4	Screw .....	9611993680	9611993268
57	4	Washer .....	9611990703	9611993269
53	4	Screw .....	9611991907	
59	4	Pivot screw .....	9611991763	
60	2	Leg bracket .....		9612518401
61	4	Nut for leg .....		9611993260
62	4	Screw for leg .....		9612518501

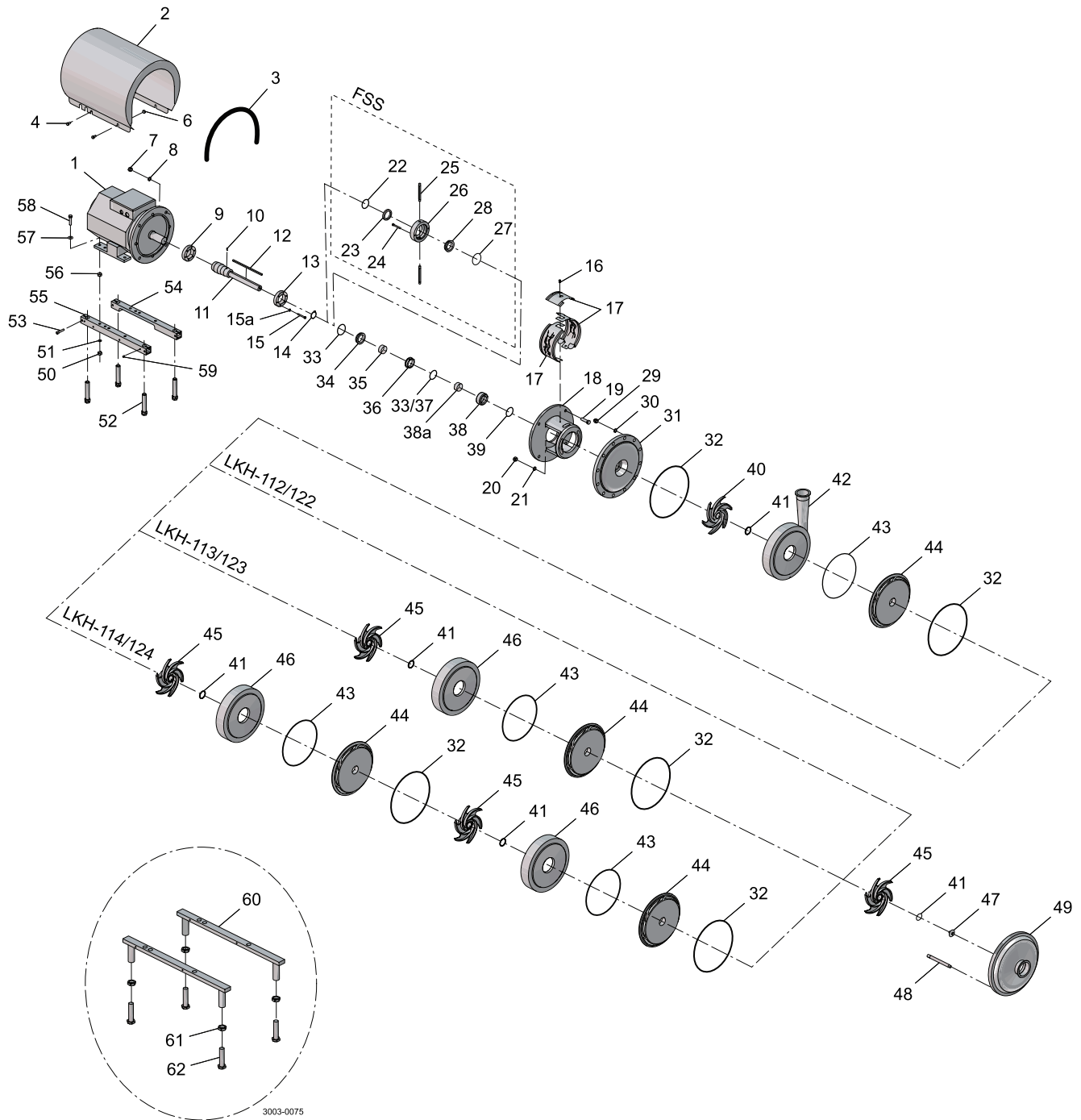

LKH Multi-Stage - Motor dependent parts

Pos	Qty	Denomination	2.2 kW	3 kW	4 kW
			IEC90	IEC100	IEC112
1	1	Motor ABB 3000rpm, - LKH110 .....	9614303004	9614303005	9614303006
	1	Motor ABB 3000rpm special bearing, - LKH110P .....	9614289501		9614289502

Pos	Qty	Denomination	5.5 kW	7.5 kW	11 kW
			IEC132	IEC132	IEC160
1	1	Motor ABB 3000rpm, - LKH110 .....	9614303007	9614303008	9614303009
	1	Motor ABB 3000rpm special bearing, - LKH110P .....	9614289503	9614289504	9614289505

Pos	Qty	Denomination	15 kW	18.5 kW	22 kW
			IEC160	IEC160	IEC180
1	1	Motor ABB 3000rpm, - LKH110 .....	9614303010	9614303011	9614303012
	1	Motor ABB 3000rpm special bearing, - LKH110P .....	9614289506	9614289507	9614289508
	1	Motor ABB 3000rpm special bearing, - LKH120 .....			9614289509

Pos	Qty	Denomination	30 kW	37 kW	45 kW
			IEC200	IEC200	IEC200
1	1	Motor ABB 3000rpm special bearing, - LKH120 .....	9614289510	9614289511	9614289512

Pos	Qty	Denomination	55 kW	75 kW
			IEC250	IEC250
1	1	Motor ABB 3000rpm special bearing, - LKH120 .....	9614289513	9614289514

3 ~, 50 Hz, 230VD/400-415VY - Standard ≤ 22 kW and 400-415VD/690VY Standard > 22 kW

3 ~, 60 Hz, 440-460VY - Standard ≤ 22 kW and 440-460VD Standard > 22 kW

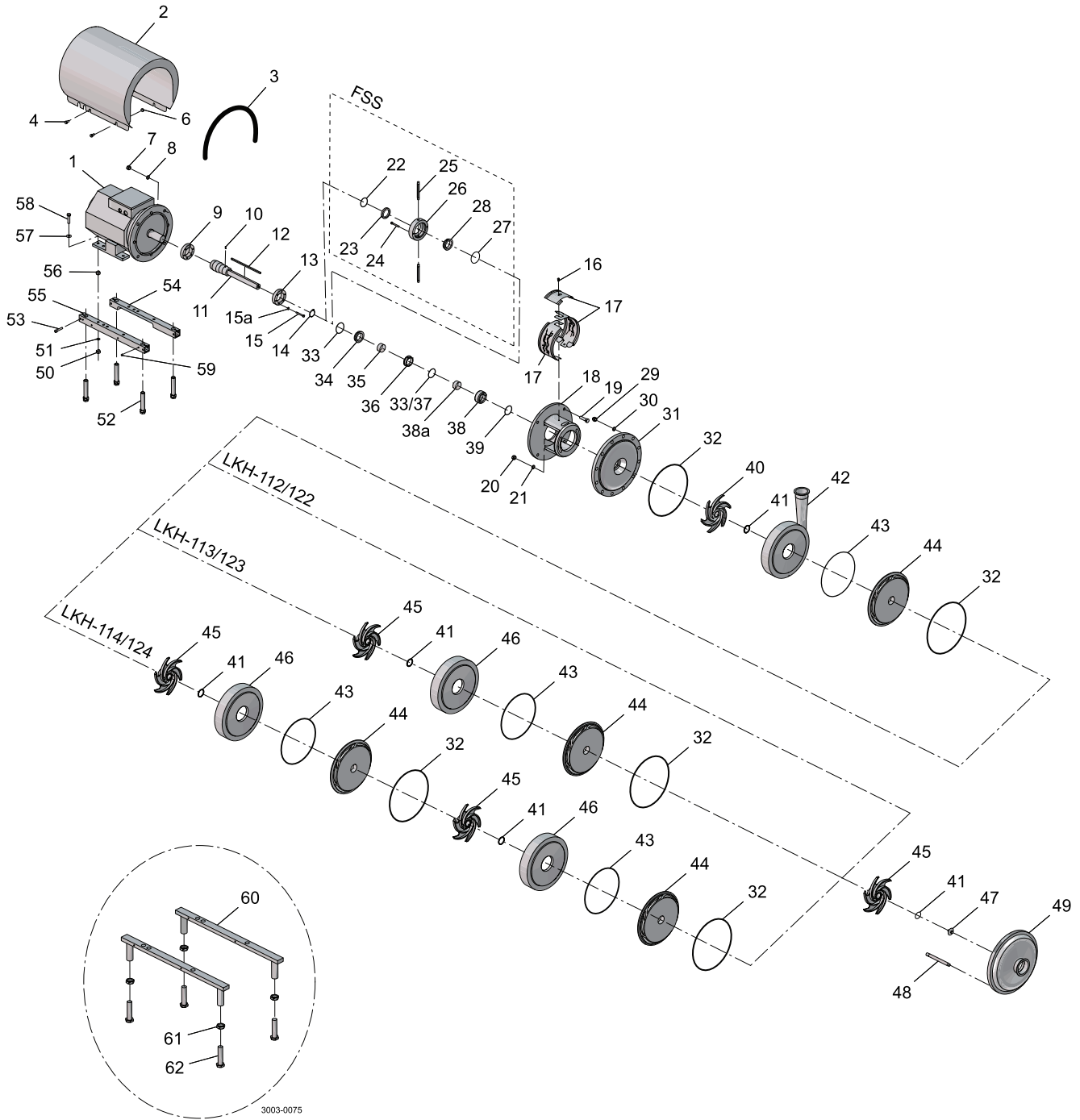

Pos	Qty	Denomination	LKH-	LKH-
			112/113/114	122/123/124
			LKH-112P/ 113P/114P	
60	1	Set of 8 springs for rotating sealhousing (incl. In pos 38) .....	9611995848	9911995849
35	1	Spacing ring .....	9612362501	9612362503
38	1	Rotating seal housing .....	9612362401	9612604501
<b>Parts for flushed shaft seal</b>				
22	◆○	1 O-ring, EPDM .....	9611992754	9611993586
23	◆○	1 Sleeve .....		
24		2 Screw .....	9611990203	9611994038
25		2 Tube .....	9612358901	9612358909
26		1 Seal housing, for flushed seal .....	9612362601	9612362603
27	◆○	1 O-ring, EPDM .....	9611992753	9611992753
28	◆○	1 Lip seal .....	9611992860	9611993587

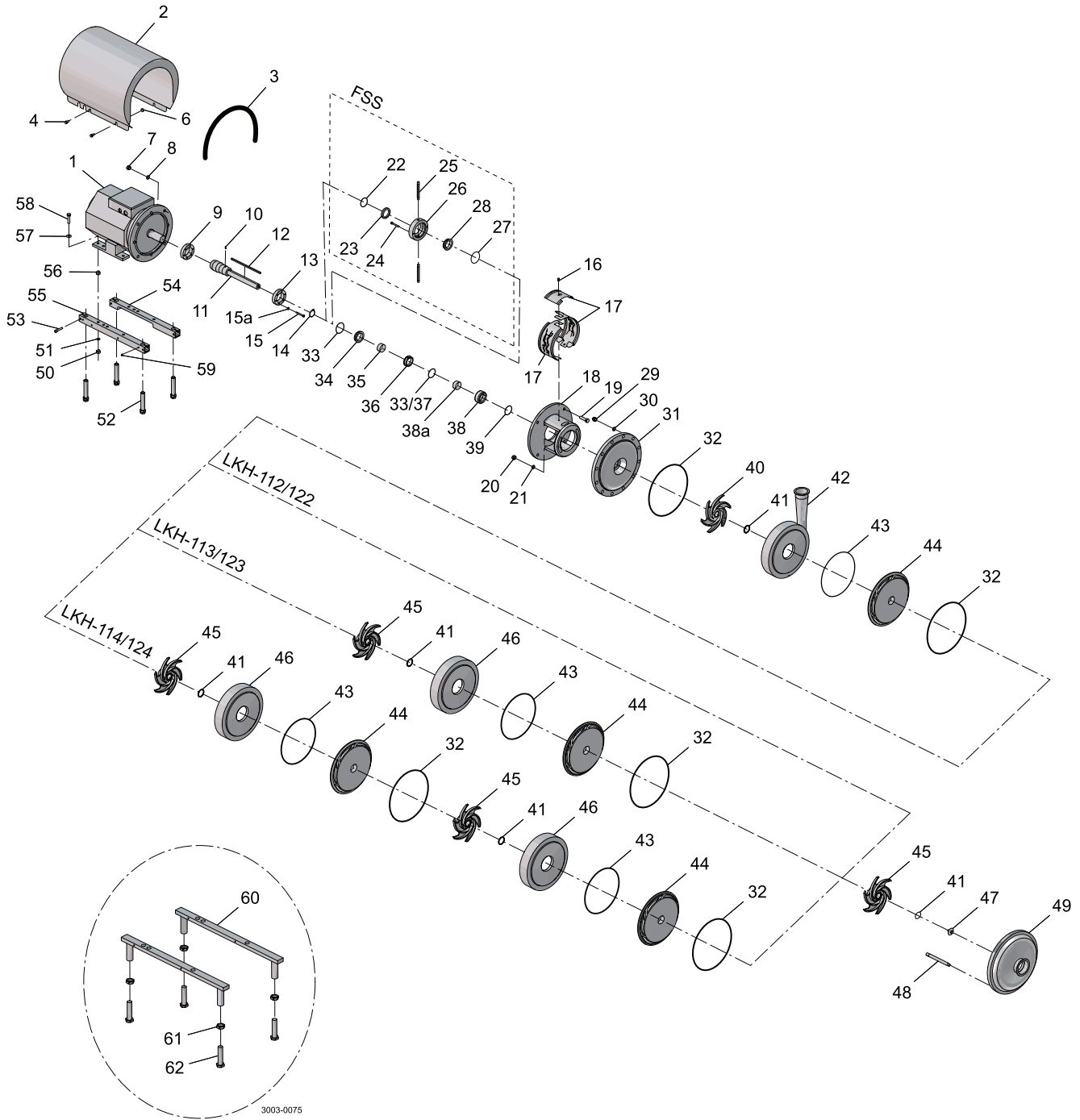

Pos	Qty	Denomination	LKH- 112/113/114, LKH-112P/ 113P/114P EPDM	LKH- 112/113/114, LKH-112P/ 113P/114P NBR	LKH- 112/113/114, LKH-112P/ 113P/114P FPM
-----	-----	--------------	--	---	---

**Single shaft seal C/SIC**

□○		Shaft seal complete .....	9612362201	9612362202	9612362203
33	1	O-ring .....			
34	1	Stationary seal ring, Sic. ....			
36	1	Rotating seal ring, Carbon .....			
37	1	Quad ring .....			
38a	1	Support ring, PTFE .....			
39	1	Quad ring .....			

**Single shaft seal SiC/SIC**

◆■		Shaft seal complete .....	9612362204	9612362205	9612362206
33	1	O-ring .....			
34	1	Stationary seal ring, Sic. ....			
36	1	Rotating seal ring, SIC .....			
37	1	Quad ring .....			
38a	1	Support ring, PTFE .....			
39	1	Quad ring .....			

Pos	Qty	Denomination	LKH- 122/123/124, EPDM	LKH- 122/123/124, NBR	LKH- 122/123/124, FPM
-----	-----	--------------	------------------------------	-----------------------------	-----------------------------

**Single shaft seal C/SIC**

□○		Shaft seal complete .....	9612602401	9612602402	
33	1	O-ring, EPDM .....			
34	1	Stationary seal ring, Sic. ....			
36	1	Rotating seal ring, Carbon .....			
37	1	Quad ring .....			
38a	1	Support ring, PTFE .....			
39	1	Quad ring .....			
33	1	O-ring (EPDM) .....			

**Single shaft seal SiC/SIC**

◆■		Shaft seal complete .....	9612602404	9612602405	
33	1	O-ring, EPDM .....			
34	1	Stationary seal ring, Sic. ....			
36	1	Rotating seal ring, SIC .....			
37	1	Quad ring .....			
38a	1	Support ring, PTFE .....			
39	1	Quad ring .....			
33	1	O-ring (EPDM) .....			

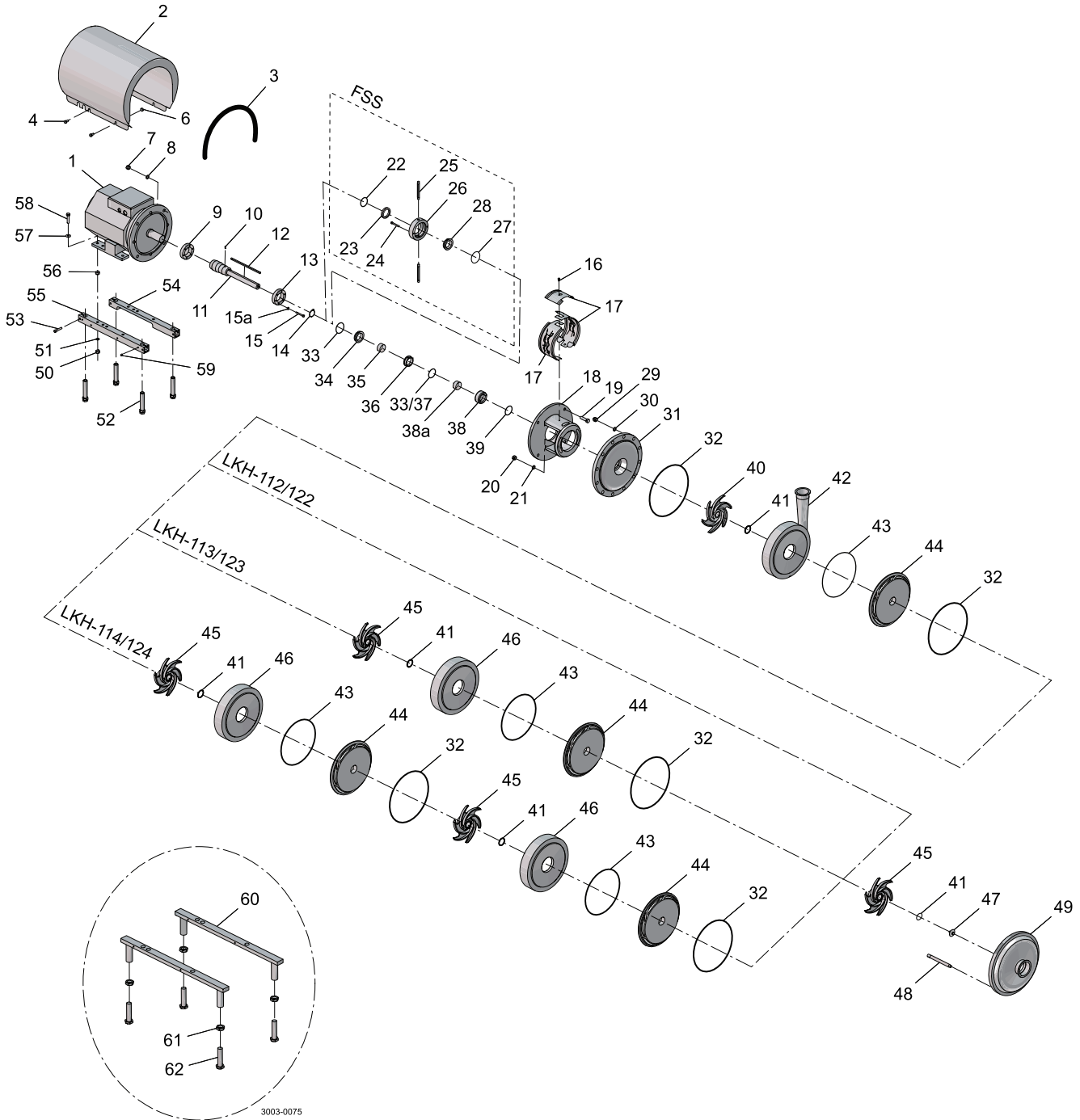

		EPDM	NBR	FPM
<b>Service kit for single shaft seal C/SIC</b>				
□	Service kit C/SIC LKH-112/ LKH-112P .....	9611922096	9611922097	9611922098
	Service kit C/SIC LKH-113/ LKH-113P .....	9611922102	9611922103	9611922104
	Service kit C/SIC LKH-114/ LKH-114P .....	9611922108	9611922109	9611922110
	Service kit C/SIC LKH-122 .....	9611922409	9611922410	
	Service kit C/SIC LKH-123 .....	9611922934	9611922935	
	Service kit C/SIC LKH-124 .....	9611922940	9611922941	
<b>Service kit for single shaft seal SIC/SIC</b>				
■	Service kit SIC/SIC LKH-112/ LKH-112P .....	9611922655	9611922656	9611922657
	Service kit SIC/SIC LKH-113/ LKH-113P .....	9611922661	9611922662	9611922663
	Service kit SIC/SIC LKH-114/ LKH-114P .....	9611922667	9611922668	9611922669
	Service kit SIC/SIC LKH-122 .....	9611922673	9611922674	
	Service kit SIC/SIC LKH-123 .....	9611922679	9611922680	
	Service kit SIC/SIC LKH-124 .....	9611922685	9611922686	
<b>Service kit for flushed shaft seal C/SIC</b>				
○	Service kit C/SIC LKH-112/ LKH-112P .....	9611922099	9611922100	9611922101
	Service kit C/SIC LKH-113/ LKH-113P .....	9611922105	9611922106	9611922107
	Service kit C/SIC LKH-114/ LKH-114P .....	9611922111	9611922112	9611922113
	Service kit C/SIC LKH-122 .....	9611922412	9611922413	
	Service kit C/SIC LKH-123 .....	9611922937	9611922938	
	Service kit C/SIC LKH-124 .....	9611922943	9611922944	
<b>Service kit for flushed shaft seal SIC/SIC</b>				
◆	Service kit SIC/SIC LKH-112/ LKH-112P .....	9611922658	9611922659	9611922660
	Service kit SIC/SIC LKH-113/ LKH-113P .....	9611922664	9611922665	9611922666
	Service kit SIC/SIC LKH-114/ LKH-114P .....	9611922670	9611922671	9611922672
	Service kit SIC/SIC LKH-122 .....	9611922676	9611922677	
	Service kit SIC/SIC LKH-123 .....	9611922682	9611922683	
	Service kit SIC/SIC LKH-124 .....	9611922688	9611922689	

Parts marked with □◆○■ are included in the service kits.

Recommended Spare Parts: Service kits.

Conversion single to flushed shaft seal : Please order Flushed service kit + pos. 10+24+25+26

(900732/7)

**How to contact Alfa Laval**

Contact details for all countries are continually updated on our website.

Please visit [www.alfalaval.com](http://www.alfalaval.com) to access the information directly.

© Alfa Laval Corporate AB

This document and its contents is owned by Alfa Laval Corporate AB and protected by laws governing intellectual property and thereto related rights. It is the responsibility of the user of this document to comply with all applicable intellectual property laws. Without limiting any rights related to this document, no part of this document may be copied, reproduced or transmitted in any form or by any means (electronic, mechanical, photocopying, recording, or otherwise), or for any purpose, without the expressed permission of Alfa Laval Corporate AB. Alfa Laval Corporate AB will enforce its rights related to this document to the fullest extent of the law, including the seeking of criminal prosecution.